

PRODUCT SHEET

Description:

180DG Baluster SS316 Brushed, $\varnothing 42,4 \times 2 \times 970 \text{mm}$, 4 Holes Two Side

Item number:

22.10.413-9

Units	Box	Carton	HS Code	Barcode
Pcs.	1	4	8302419000	
				5704866499828

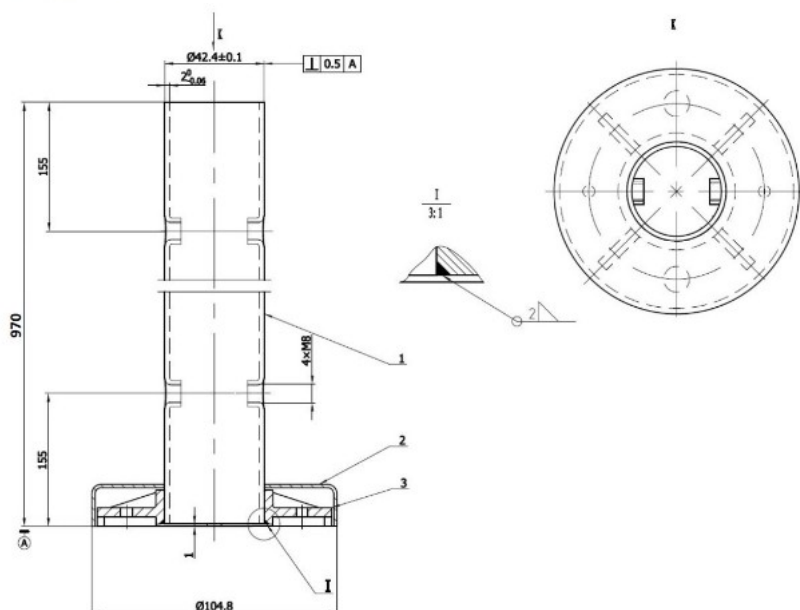

SISO A/S

Mileparken 11
DK-2740 Skovlunde
Denmark
VAT: DK 24786013

Phone +45 45 830 900

www.siso.dk
siso@siso.dk

Danske Bank
Nytorv Branch
Copenhagen
SWIFT: DABADKKK

Account no.
4180 3112 112936
IBAN Account
DK7230003112112936